

2947 0.576 kg/mt

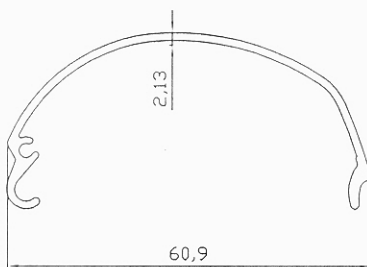

2948 0.388 kg/mt

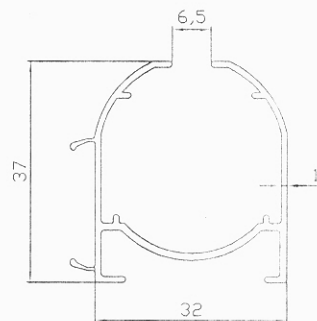

3016 0.405 kg/mt

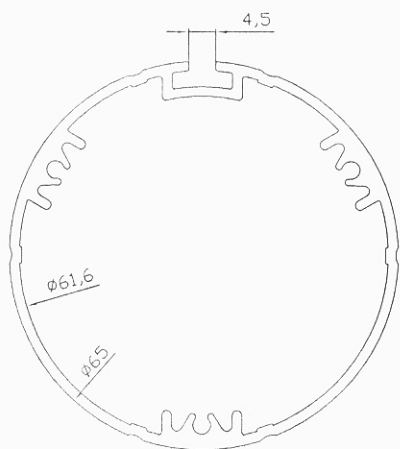

3696 1.293 kg/mt

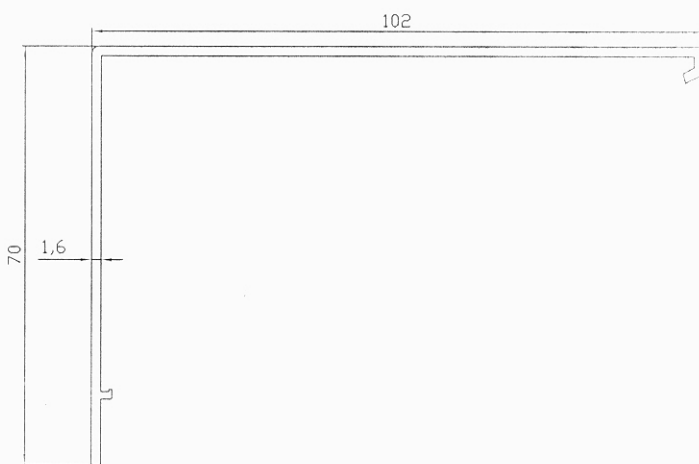

3697 0.785 kg/mt

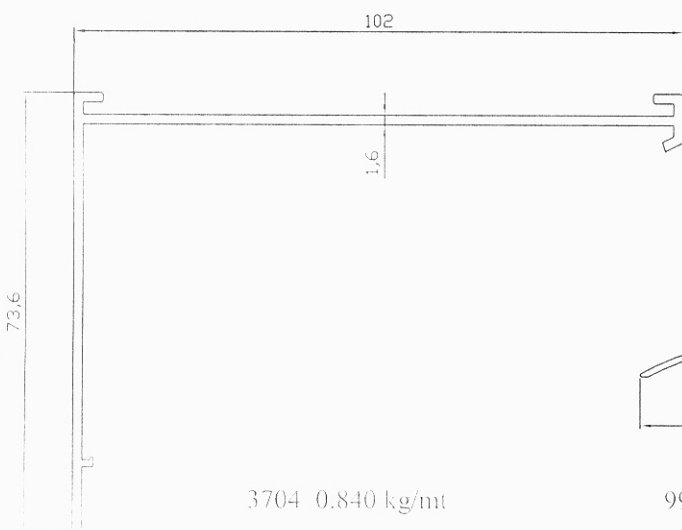

3704 0.840 kg/mt

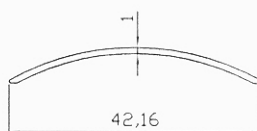

997 0.106 kg/mt



2090 - kg/mt

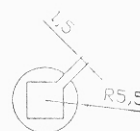

937 0.150 kg/mt