

2044 0.888 kg/m

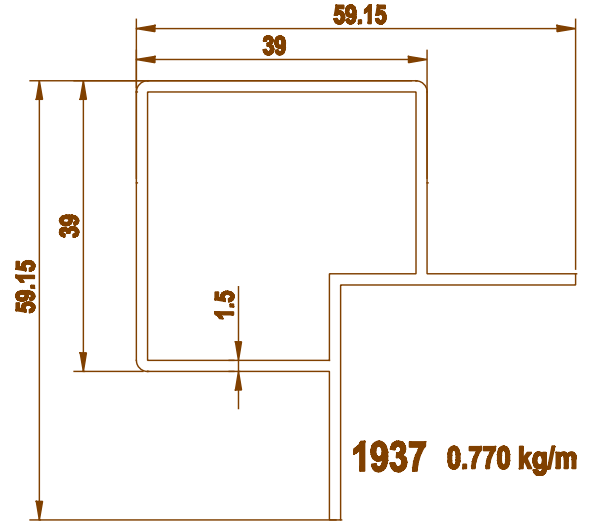

1937 0.770 kg/m

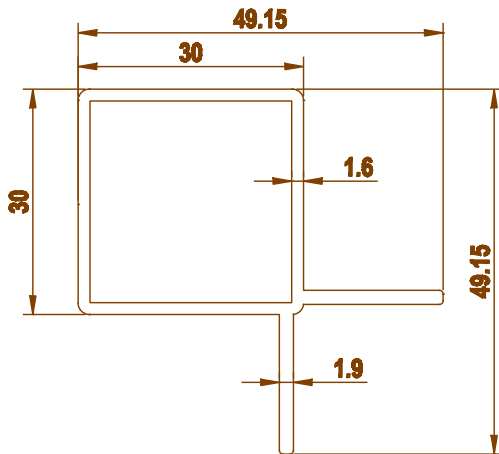

1943 0.680 kg/m

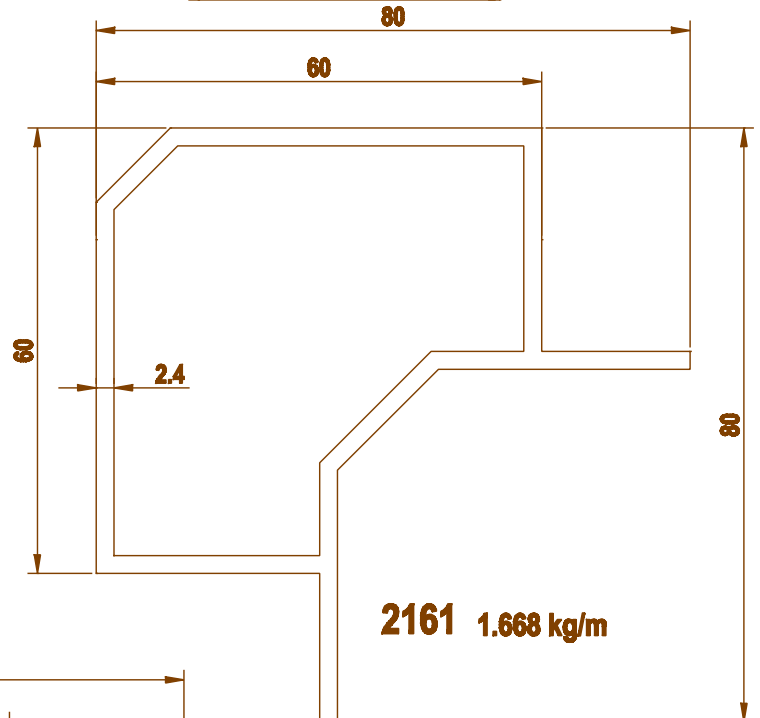

2161 1.668 kg/m

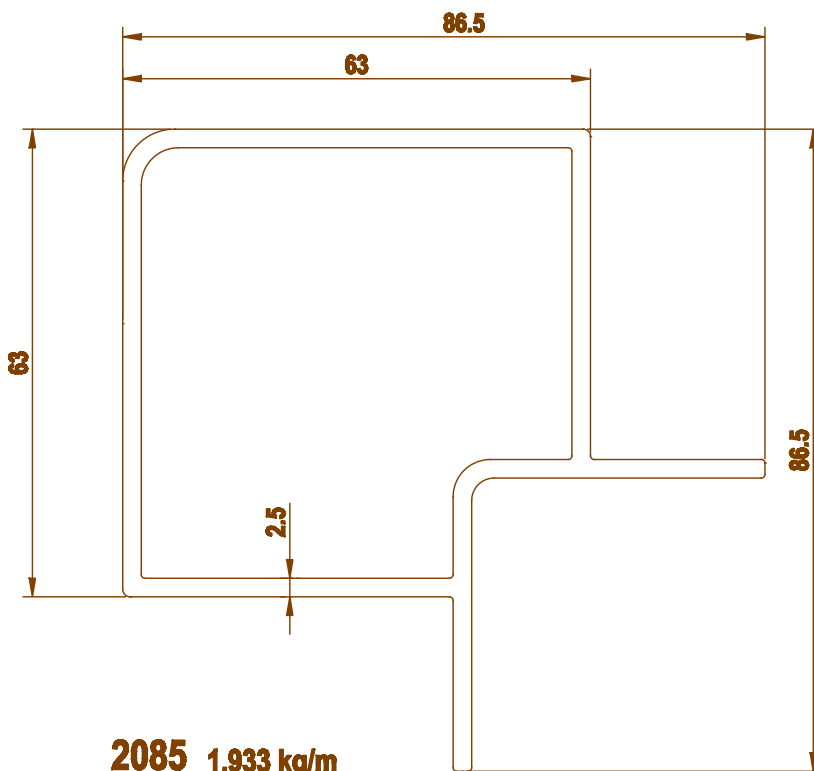

2085 1.933 kg/m