

2084 1.315 kg/m

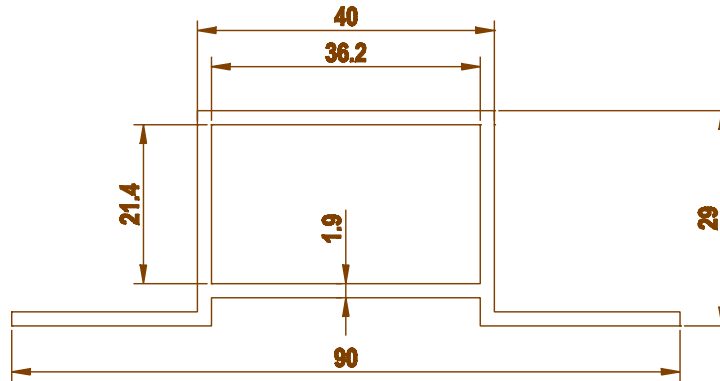

2074 0.928 kg/m

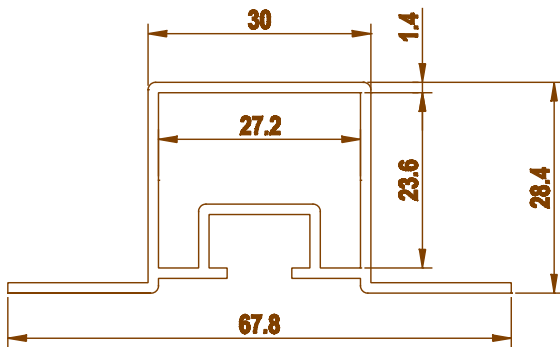

1944 0.640 kg/m

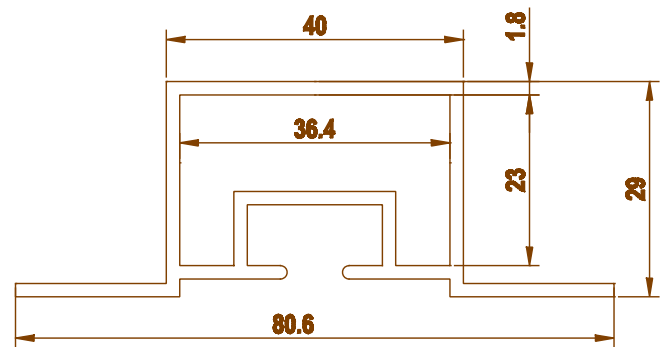

1936 0.970 kg/m

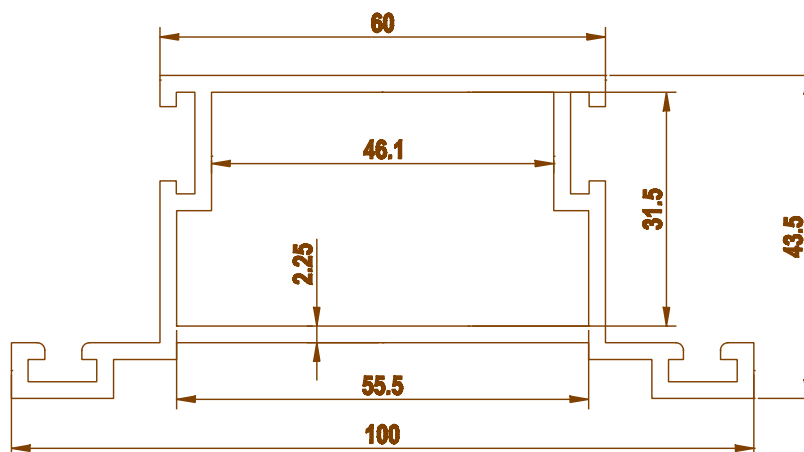

2192 1.660 kg/m